

Description

Thermal-Link (ATCO)-Alloy Type is defined as a non-resettable protective device functioning one time only. It is widely used in electrical equipment. ATCO is mainly consist of fusible alloy, flux resin, case, sealant and lead wires. Normally, fusible alloy is jointed to the two lead wires. Under abnormal conditions, when the temp. reaches to the fusing temp. of ATCO, the fusible alloy melts and quickly retracts to the two lead wire ends with the aid of the flux resin and disconnects the circuit completely.

SETsafe | SETfuse Thermal-Link (ATCO)-Alloy Type KG series Rated Functioning Temp. from 76 °C to 221 °C, Rated Current: 2 A, safety certification Includes UL, cUL, TUV, PSE, CCC, and complies with RoHS and REACH.

Features

- Non-Resettable
- High Accuracy of Functioning Temp.
- RoHS & REACH Compliant

Applications

- Lamps
- Switched-Mode Power Supplies
- Home Electrical Appliances
- Transformers
- Motors
- Batteries

Customization

- Other Temp.
- The Length of Lead Wires
- Taping Packing Available
- Lead Wires can be Insulated
- Tinned Copper Wires or CP Wires
- Leads Forming Types

Structure Diagrams

Radial

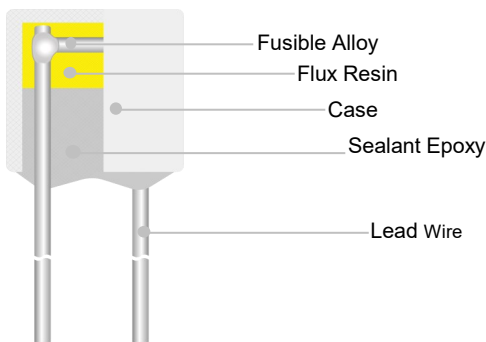

Marking

Radial (Color for reference only)

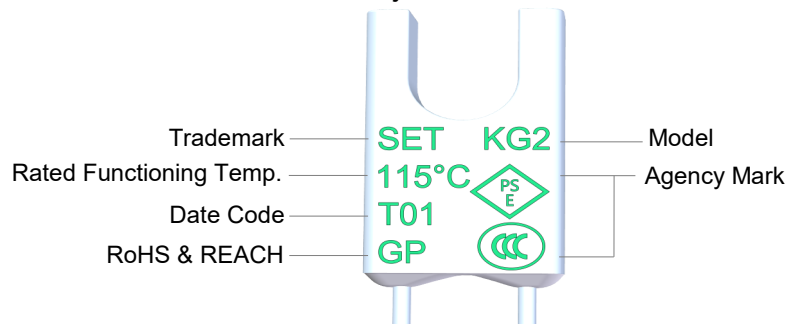

Remark: The Date Code means Year and quarter: A stands for 2000, B stands for 2001 and 01 stands for the first quarter, 02 stands for the second quarter, and so on.



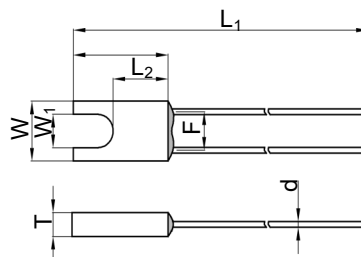

Dimensions (mm)



L	L ₁	L ₂	W	W ₁	T	d	F
10.0 ± 0.5	74.0 ± 3.0	5.8 ± 0.5	5.8 ± 0.5	3.2 ± 0.5	2.3 ± 0.2	0.54 ± 0.05	3.7 ± 0.5

Specifications

Rated Functioning Temp. (T_f) °C





	Model	Fusing Temp.	T_h	T_m	I_r	U_r						RoHS REACH
		(°C)	(°C)	(°C)	(A)	(V)	UL	cUL	TUV	PSE	CCC	
221	KG31	218 ± 2	188	250	2	AC 250	●	●	●	●	●	●
						DC *	○	○	○	○	○	○
205	KG32	199 ± 3	169	250	2	AC 250	●	●	●	●	●	●
						DC *	○	○	○	○	○	○
160	KG16	154 ± 2	135	200	2	AC 250	○	○	●	●	●	●
						DC *	○	○	○	○	○	○
150	KG7	145 ± 2	126	200	2	AC 250	●	●	●	●	●	●
						DC *	○	○	○	○	○	○
145	KG6	140 ± 2	121	200	2	AC 250	●	●	●	●	●	●
						DC *	○	○	○	○	○	○
136	KG9	131 ± 2	112	200	2	AC 250	●	●	●	●	●	●
						DC *	○	○	○	○	○	○
135	KG5	130 ± 2	111	200	2	AC 250	●	●	●	●	●	●
						DC *	○	○	○	○	○	○
133	KG8	130 ± 2	111	200	2	AC 250	●	●	●	●	●	●
						DC *	○	○	○	○	○	○
130	KG4	125 ± 2	106	200	2	AC 250	●	●	●	●	●	●
						DC *	○	○	○	○	○	○
125	KG3	121 ± 2	100	200	2	AC 250	●	●	●	●	●	●
						DC 60	●	●	○	○	○	○
115	KG2	111 ± 2	91	200	2	AC 250	●	●	●	●	●	●
						DC 60	●	●	○	○	○	○
102	KG1	98 ± 3	79	200	2	AC 250	●	●	●	●	●	●
						DC 60	●	●	○	○	○	○
86	KG18	81 ± 2	61	200	2	AC 250	●	●	●	●	●	●
						DC 60	●	●	○	○	○	○
76	KG0	73 ± 2	53	200	2	AC 250	●	●	●	●	●	●
						DC *	○	○	○	○	○	○

Note:

1: "●"Means certificated, "○"Means non-certificated, RoHS & REACH Compliant .

2: " * "Customizable DC voltage.

Agency Information

Agency Symbol	Standards	The File No. and certification No. obtained by SETsafe SETfuse
	UL 60691	E214712
	CAN-CSA-E60691	E214712
	EN 60691	R50384415
	J60691	JET2121-32001-2021、JET2121-32001-2022 JET2121-32001-2023、JET2121-32001-2024 JET2121-32001-2025、JET2121-32001-2026 JET2121-32001-2027、JET2121-32001-2028
	GB 9816.1	2020980205000195

Soldering

Hand-Soldering

- Soldering should be carried out according to Table T-1.
- The thermal element of ATCO is fusible alloy with low melting point, which is jointed with ATCO lead wires. Improper soldering operation (too high soldering temp. , too long soldering time, too short lead wire etc.) may transfer more heat to the thermal element and ATCO may open in advance.
- When soldering conditions are more severe than those listed in Table T-1, a heat sink fixture should be used between soldering point and ATCO body.
- When soldering, please do not pull / push or twist ATCO body or lead wires.
- After soldering, let it naturally cool for longer than 20 seconds. During cooling, never move the ATCO body or lead wires.

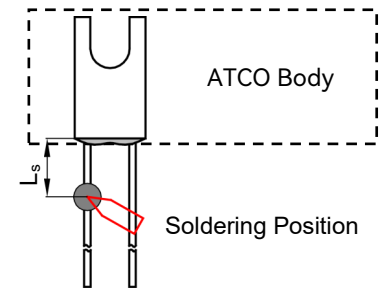

FIGURE T-1

TABLE T-1 Hand-Soldering Time

Rated Functioning Temp. (T _f)	Max. Allowable Soldering Time for Different Lead Wire Length (Fig.T-1)									Max. Soldering Temp.
	L _s Length	Time		L _s Length	Time		L _s Length	Time		
		Tinned Copper Wire	CP Wire		Tinned Copper Wire	CP Wire		Tinned Copper Wire	CP Wire	
(°C)	(mm)	(s)	(s)	(mm)	(s)	(s)	(mm)	(s)	(s)	(°C)
76 to 101	10	1 ^a	4	20	2	5	30	3	6	400
102 to 115	10	1 ^a	4	20	2	5	30	3	6	
116 to 135	10	1 ^a	4	20	3	6	30	5	8	
136 to 150	10	3	6	20	5	8	30	5	8	
151 to 221	10	4	7	20	6	9	30	7	10	

Note:

a: Auxiliary Heat Sink Fixture is Required to Avoid ATCO Cutting off Unexpectedly.

Wave Soldering

The wave soldering parameters as Table T-2, for reference only, when ATCO is for practice use, you need to do some validation experiments. For example, using X-RAY to see the fusible alloy of ATCO whether damage after wave soldering.

TABLE T-2 Wave Soldering Parameters Setting

Rated Functioning Temp. (T_f)	Max. Allowable Preheating Temp. When the Length of Lead Wire is Different (Fig.T-1)				Preheating Time (t_1)	Max. Wave Soldering Temp.	Dwelling Time (t_2)	Cooling Time (t_3)
	L_s Length	Preheating Temp.	L_s Length	Preheating Temp.				
(°C)	(mm)	(°C)	(mm)	(°C)	(s)	(°C)	(s)	(s)
76 to 130	Recommend Hand-Soldering							
131 to 150	20	80	30	90	< 60	≤ 260	≤ 3	≤ 10
151 to 221	20	90	30	100	< 60	≤ 260	≤ 3	≤ 10

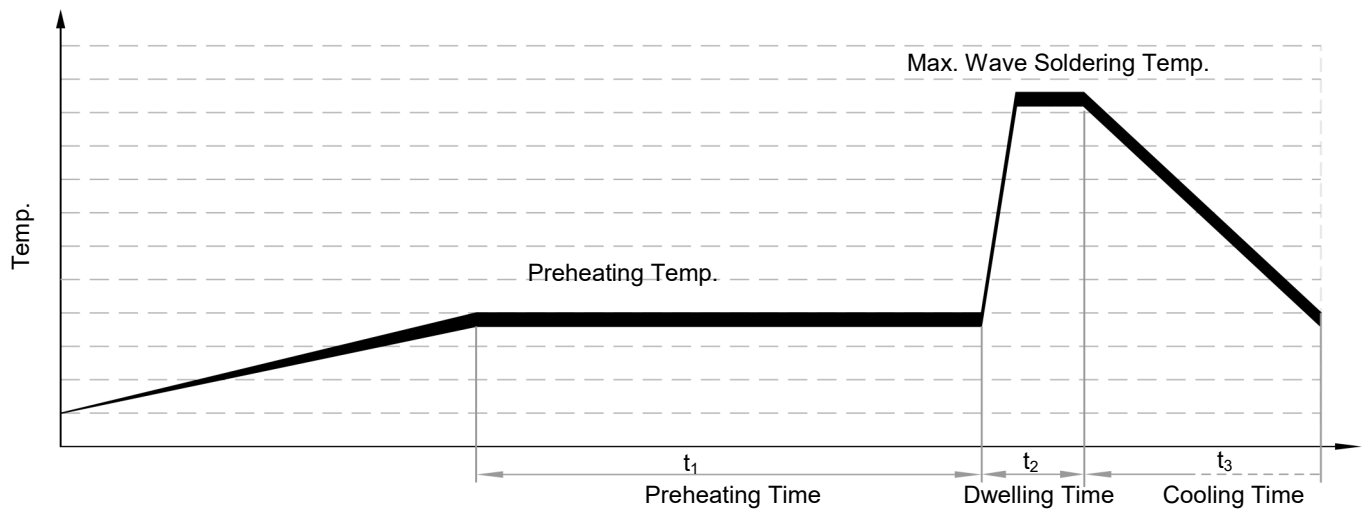

Product Temp.-Time Curve (Reference)

The Temp.-Time Curve of Thermal-Link in different temp. oil bath.

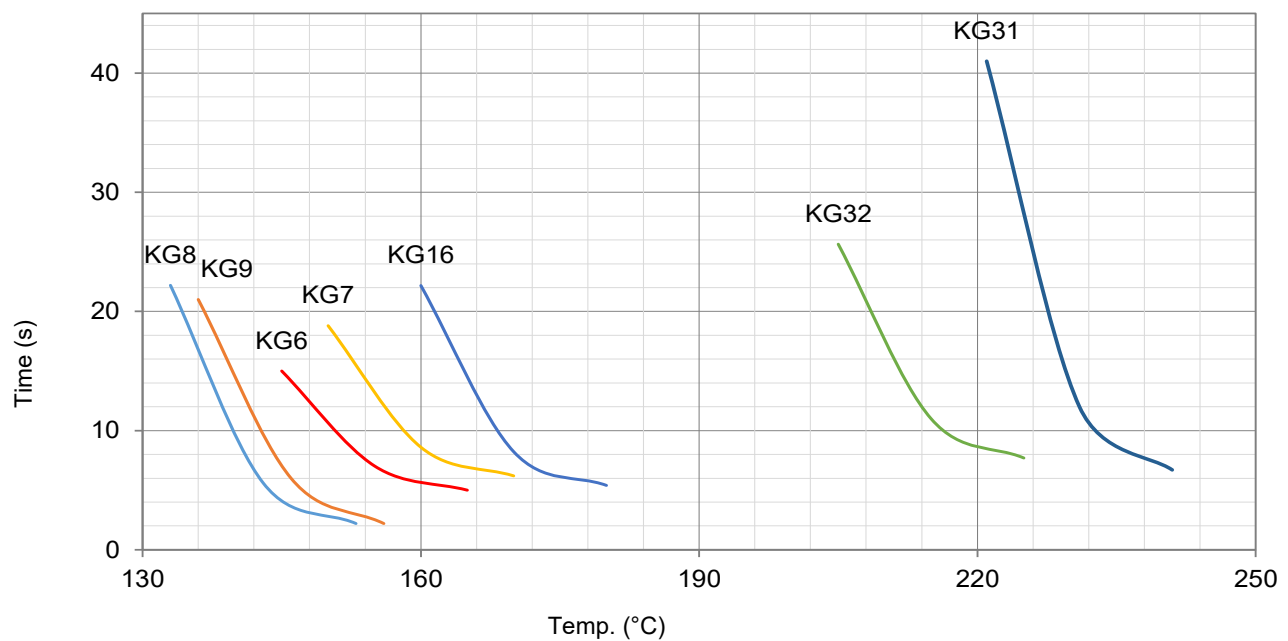
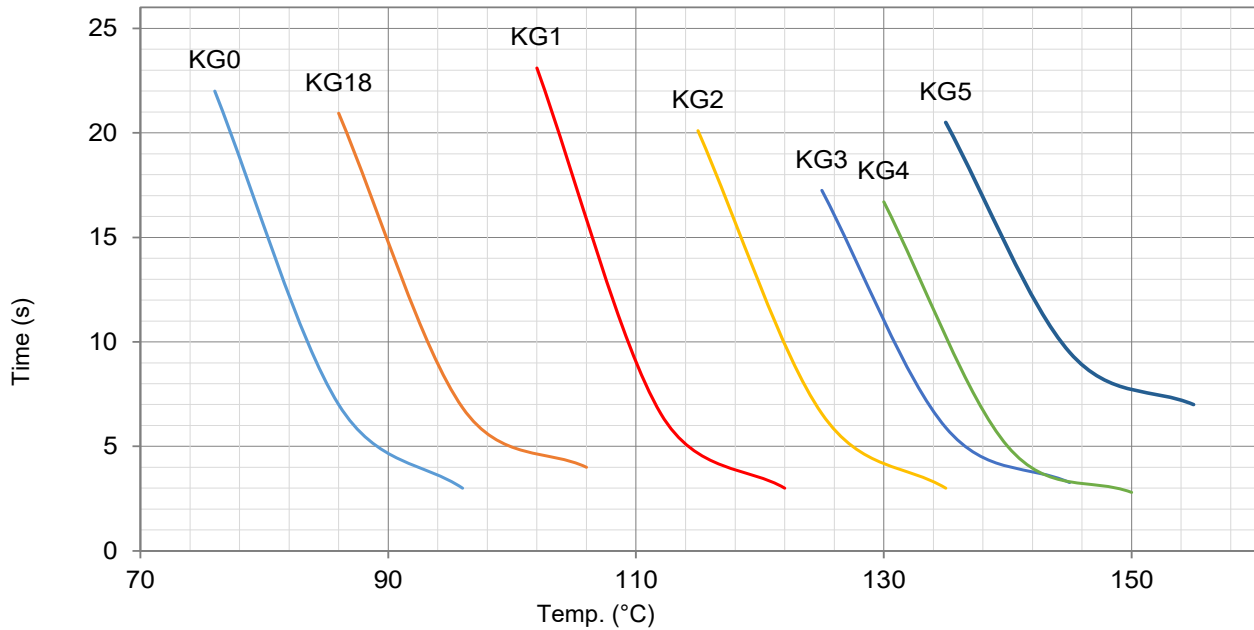

Product Current-Time Curve (Reference)

The Current-Time Curve shows functioning time at multi-times rated current at room temperature $25 \pm 2 \text{ }^\circ\text{C}$.

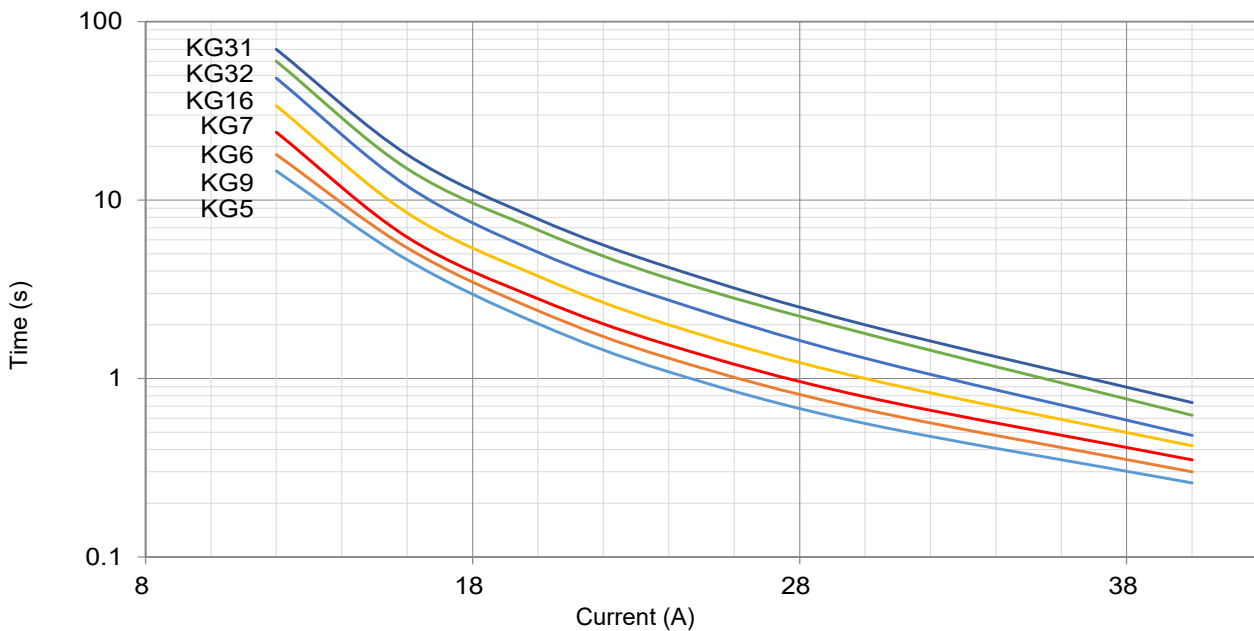
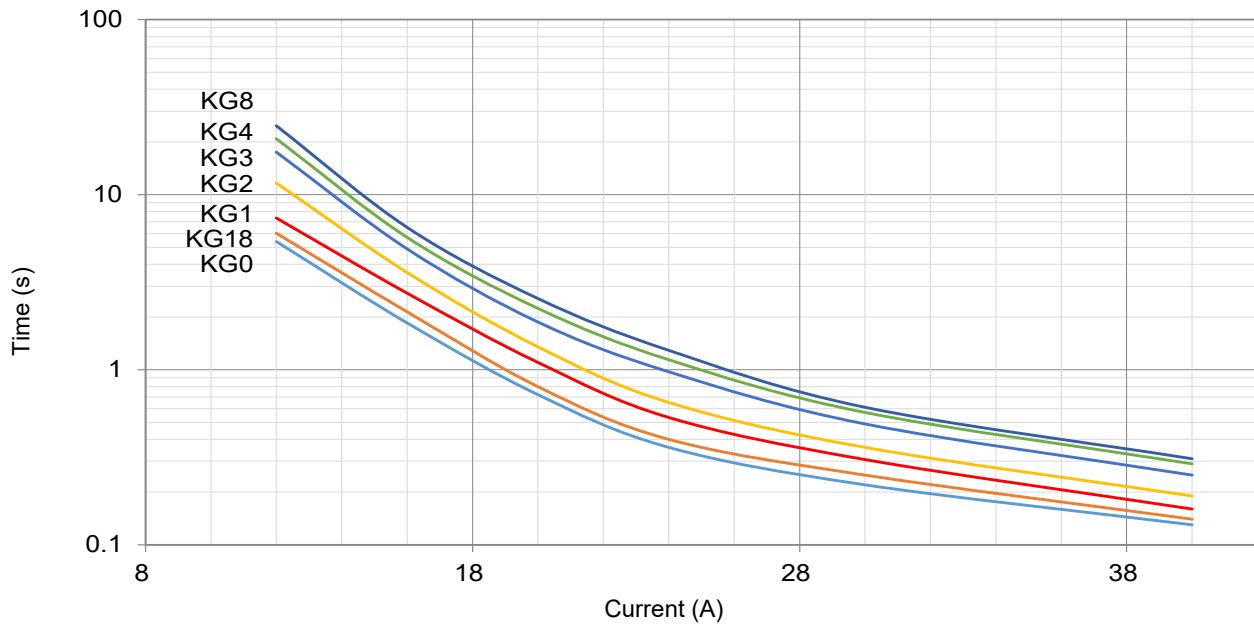

Packaging Information

Bulk

Item	Box	Carton
Dimensions (mm)	170 × 117 × 50	490 × 365 × 260
Quantity (PCS)	700	28000
Gross Weight (kg)		12.8 ± 10%

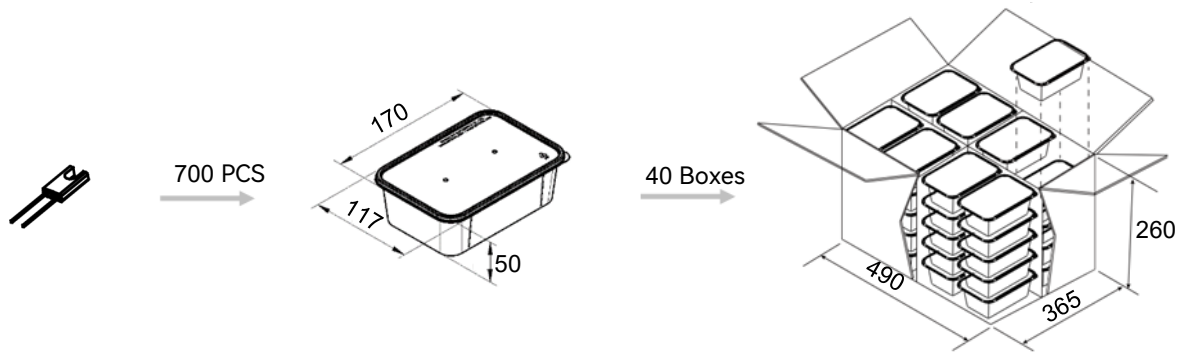

Taping

Item	Box	Carton
尺寸 (mm)	328 × 200 × 70	480 × 340 × 220
数量 (PCS)	2000	12000
毛重 (kg)		6 ± 10%

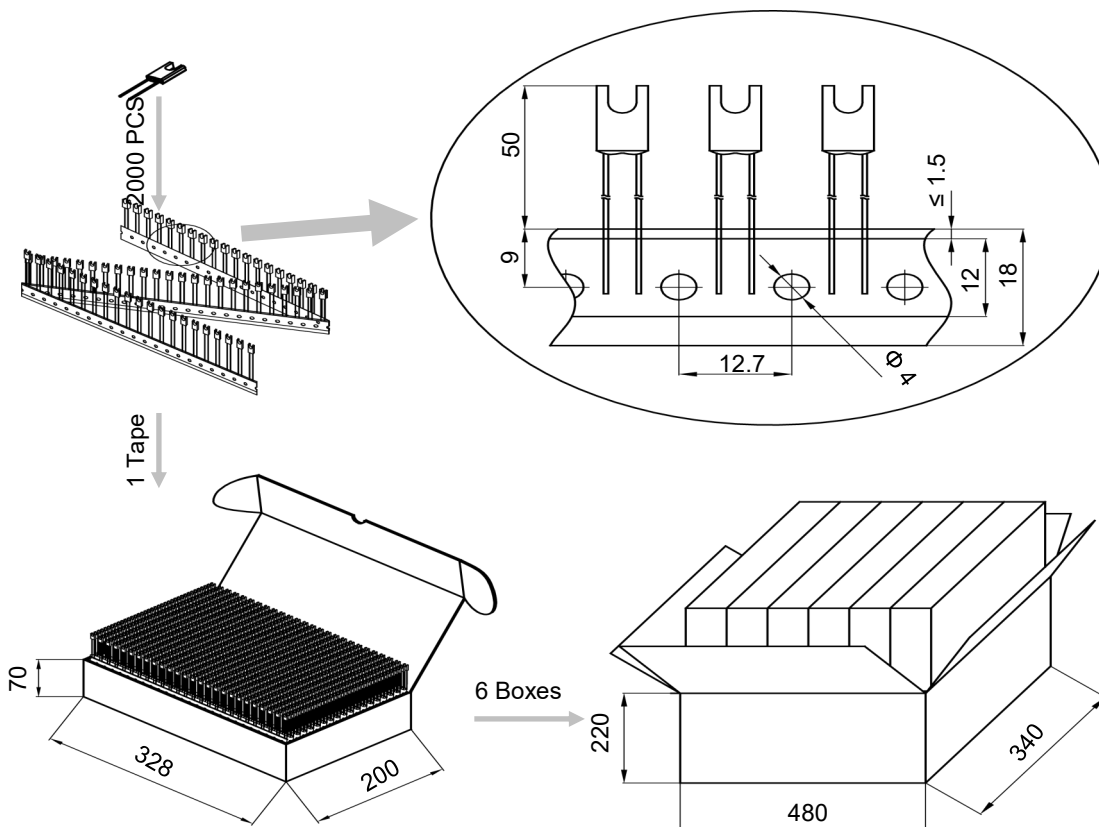

Part Numbering System

ATCO - KG 2 - A N N A B - 001

Other Options

Packing

- B Bulk
- T Taping

Leads Forming

- A Straight Lead
- B Single Lead Bending
- C Leads Bending
- D Leads Kinking
- E Leads Bending and Kinking

Color of Insulation Tube

- W White
- Y Yellow
- R Red
- K Black
- N None

Insulation Tube Material

- T Teflon
- P Polyester
- N None

Lead Wire Type

- A Tinned Copper Wire
- B Tinned Copper Plated Wire

Rated Functioning Temp.

- 2 115 °C, See Specifications

Series

- KG Series
See Specifications

Product Category

ATCO Alloy Thermal-Link

Glossary

Item	Description
TCO	<p>Thermal-Link A non-resettable device incorporating a THERMAL ELEMENT which will open a circuit once only when exposed for a sufficient length of time to a temperature in excess of that for which it has been designed.</p> <p>— (GB 9816.1)</p>
ATCO	<p>Alloy Thermal-Link Alloy Type Thermal-Link, Alloy is the thermal element.</p> <p>— (GB 9816.1)</p>
T_f	<p>Rated Functioning Temp. The temperature of the Alloy Thermal-Link which causes it to change the state of conductivity with a detection current up to 10 mA as the only load.</p> <p>— (GB 9816.1)</p> <p>Tolerance: T_f °C (GB 9816.1, EN 60691, K60691). Tolerance: $T_f \pm 7$ °C (J60691).</p>
Fusing Temp.	<p>Fusing Temp. The temperature of the Alloy Thermal-Link which causes it to change its state of conductivity is measured with silicone oil bath in which the temperature is increased at the rate of 0.5 °C to 1 °C / minute, with a detection current up to 10 mA as the only load.</p> <p>— (GB 9816.1)</p>
T_h	<p>Holding Temp. The Maximum temperature at which a Alloy Thermal-Link will not change its state of conductivity when conducting rated current for 168 hours.</p> <p>— (GB 9816.1)</p>
T_m	<p>Maximum Temp. Limit The temperature of the Alloy Thermal-Link stated by the manufacturer, up to which the mechanical and electrical properties of the Alloy Thermal-Link having changed its state of conductivity, will not be impaired for a given time.</p> <p>— (GB 9816.1)</p>
I_r	<p>Rated Current The current used to classify a Alloy Thermal-Link.</p> <p>— (GB 9816.1)</p>
U_r	<p>Rated Voltage The voltage used to classify a Alloy Thermal-Link.</p> <p>— (GB 9816.1)</p>
I_n	<p>Nominal Discharge Current Being able to withstand 15 peak currents of waveform 8/20 μs to test the product's durability of withstanding pulse current.</p>
I_{max}	<p>Max. Discharge Current Being able to withstand 1 peak current of waveform 8/20 μs to test max. pulse current that the product can withstand.</p> <p>— (UL 1449)</p>



ATTENTION

Usage

1. When atmosphere pressure is from 80 kPa to 106 kPa, the related altitude shall be from 2000 meters to - 500 meters.
2. Operating voltage less than rated voltage of ATCO, operating current less than rated current of ATCO.
3. Do not touch the ATCO body or lead wires directly when power is on, to avoid burn or electric shock.

Replace

ATCO is a non-repairable product. For safety sake, it shall be replaced by an equivalent ATCO from the same manufacturer, and mounted in the same way.

Storage

Do not store the ATCO at the high temp., high humidity or corrosive gas environment, avoid influencing the solder-ability of the lead wires, the product shall be used up within 1 year after receiving the goods.

Installation

Make Sure the Temp. of Installation Position.

1. It is recommended that a dummy ATCO with inbuilt thermo-couple shall be used to determine the proper temp.
2. The terminal product should be tested to ensure that potential abnormal conditions do not cause ambient temp. to exceed the T_m of the ATCO.
3. Mount the ATCO at the location where temp. rises evenly.

Installation position of mechanical performance requirements.

1. Do not locate the ATCO in a place where severe vibration always occurs.
2. Ensure that the lead wire is long enough, and avoid actions such as press, tensile or twist.
3. The seal or body of ATCO must not be damaged, burned or over heated.

Mechanical Connection

Riveting

1. Choose small resistivity riveting material and be riveted.
2. A flexible lead or lead with low resistance should be used to rivet the ATCO.
3. Contact resistance should be minimal, large contact resistance will lead to higher temp., ATCO Functioning in advance.

Crimping

1. Choose small resistivity crimping material and be crimped.
2. A flexible lead or lead with low resistance should be used to rivet the ATCO.
3. Contact resistance should be minimal, large contact resistance will lead to higher Temp., ATCO Functioning in advance.

Lead Wire Forming

1. If lead wire has to be bent, please pay attention to the distance between body and bending point. Refer to Table T-3.
2. When bending leads, please use pincher or similar tools to fix the product as shown in Fig.T-2, to avoid damaging the product.
3. During forming and mounting, lead wire should not be cut, nicked, bent sharply, to avoid breaking the product.
4. Tangential forces on the leads must be avoided (i.e. pushing or pulling on the leads at angle to ATCO body) as such forces may damage the seal of ATCO.

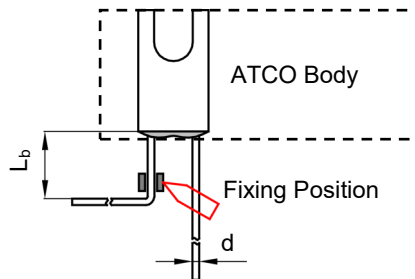

FIGURE T-2

TABLE T-3 Distance between Body and Bending Point

Circular lead	d	(mm)	< 1.0	1.0 - 1.2	> 1.2
	L_b	(mm)	≥ 3	≥ 5	≥ 10

Leads Forming Types

The below leads forming is for reference, more leads forming can be customized.

Radial

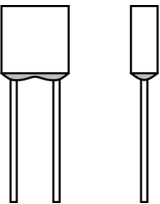
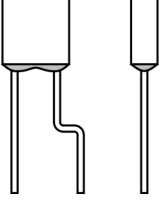
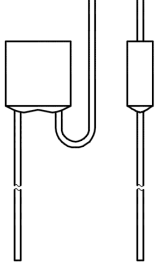
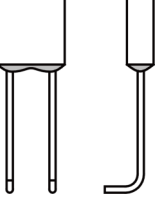
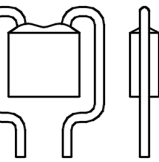
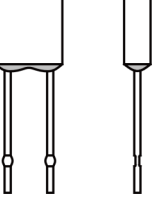
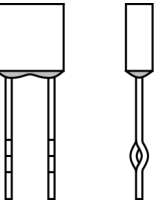
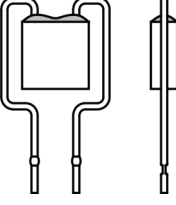
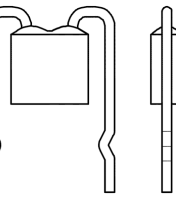

A	B	C	D	E
	 	 	 	 

Thermal-Link (ATCO)-Alloy Type Feature & Model List Overview

Rated Functioning Temp. T_r (°C)	Model																								
	SY145	TY145	KM7	XM7	YM7	Y7	SM150	TM150		KM7	XM7			YM7	HU7	HR7			YM7	HC7		HL7	HW7		
230																									
221																									
205																									
200																									
187																									
160																									
150			KM7	XM7	YM7	Y7	SM150	TM150		KM7	XM7			YM7	HU7	HR7			YM7	HC7		HL7	HW7		
145	SY145	TY145													HU6	HR6	HS145	HP145		HC6	HN145	HL6	HW6		
139																									
136					YM9	Y9	SM136	TM136	Q136			P136	Q136	YM9			HS136	HP136	YM9		HN136				
135			KM5	XM5						KM5	XM5				HU5	HR5				HC5		HL5	HW5		
133																									
130	SY130	TY130	KM4	XM4	YM4	Y4				KM4	XM4			YM4	HU4	HR4			YM4			HL4	HW4		
125	SY125	TY125								KM3	XM3	P125	Q125		HU3	HR3	HS125	HP125		HC3	HN125	HL3	HW3		
123																									
120	SY120	TY120																							
115	SY115	TY115					SM115	TM115	Q115			P115	Q115		HU2	HR2				HC2		HL2	HW2		
105	SY105	TY105																							
102							SM102	TM102				P102	Q102		HU1	HR1				HC1		HL1	HW1		
97																									
95	SY95	TY95																							
86															HU18	HR18				HC18		HL18	HW18		
76															HU0	HR0				HC0		HL0	HW0		
I_r (A) Rated Current	10	15	2	3	5	5	10	15 16	25	2	3	20	25	5	10	15	5	10	5	5	15	10	15		
U_r (VAC) Rated Voltage	250		300					320		400		500			690			800							
Product Structure																									
	Cylindrical		Radial Shape					Radial Shape		Radial Shape		Axial Shape			Axial Shape (Flat Electrode)			Radial Shape		Axial Shape		Axial Shape (Flat Electrode)		Axial Shape	

Lead wire can be customized.

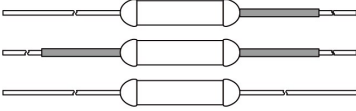
Thermal-Link (ATCO)-Alloy Type Feature & Model List Overview

Rated Functioning Temp. T_f (°C)	230	○	○	○	○	○	○	○	○	○	○	○	○	○	○	○	○	○	○	○	○		
	221	○	○	○	○	○	V31	H31	○	B31	○	○	○	○	○	○	○	○	○	U31	○	R31	
	205	○	○	○	○	○	V32	H32	○	B32	○	○	○	○	○	○	○	○	○	U32	○	R32	
	200	○	○	○	○	○	○	○	○	○	○	○	○	○	○	○	○	○	○	○	○	○	
	187	○	○	○	○	○	○	○	○	○	○	○	○	○	○	○	○	○	○	○	○	○	
	160	○	○	○	○	○	V16	H16	○	B16	○	○	○	○	○	○	○	○	○	U16	○	R16	
	150	V7	H7	B7	○	C7	○	○	○	○	○	○	○	○	○	○	○	○	○	U7	○	R7	
	145	V6	H6	B6	○	C6	○	○	○	○	○	○	○	○	○	○	○	○	C6	U6	○	R6	
	139	V13	H13	B13	○	C13	○	○	○	○	○	SF13	V13	○	○	○	○	C13	M13	○	○	CR13	○
	136	V9	H9	B9	○	C9	○	○	○	○	○	○	○	○	○	○	○	○	○	○	○	○	○
	135	V5	H5	B5	○	C5	○	○	○	○	○	○	○	○	○	○	○	○	○	○	U5	○	R5
	133	V8	H8	B8	○	C8	○	○	○	○	○	SF8	○	V8	○	○	○	○	○	○	○	○	○
	130	V4	H4	B4	○	C4	○	○	○	○	○	SF4	○	V4	○	○	○	○	○	○	U4	○	R4
	125	V3	○	B3	○	C3	○	H3	○	○	○	○	○	○	○	○	○	○	○	○	U3	○	R3
	123	○	○	○	○	○	○	○	○	○	○	○	○	○	○	○	○	○	○	○	○	○	○
	120	○	○	○	○	○	○	○	○	○	○	○	○	○	○	○	○	○	○	○	○	○	○
	115	V2	H2	B2	○	C2	○	○	○	○	○	SF2	○	V2	○	○	○	C2	○	○	U2	○	R2
	105	○	○	○	○	○	○	○	○	○	○	○	○	○	○	○	○	○	○	○	○	○	○
	102	V1	H1	B1	○	C1	○	○	○	○	○	○	○	○	○	○	○	○	○	○	U1	○	R1
	97	V21	H21	B21	○	C21	○	○	○	○	○	○	○	○	○	○	○	○	○	○	○	○	○
95	○	○	○	○	○	○	○	○	○	○	○	○	○	○	○	○	○	○	○	○	○	○	
86	V18	H18	B18	○	C18	○	○	○	V18	○	○	○	○	○	○	○	○	○	○	U18	○	R18	
76	V0	H0	B0	○	C0	○	○	○	○	○	○	○	○	○	○	○	○	○	○	U0	○	R0	
I_r (A) Rated Current		1	2	3	5	7	1	2	2.5	3	3	5	4	5	6	8	8.5	9	10	10	15	15	
U_r (VDC) Rated Voltage		50						60															
Product Structure																							
	<p>Axial Shape</p> <p>Lead wire can be customized.</p>																						
																							

Thermal-Link (ATCO)-Alloy Type Feature & Model List Overview

Rated Functioning Temp. T_r (°C)	60						100		120		125				200			Model	
	KG3	XG3	K3	X3	F6	X6	S125	T125	P125	Q125	GA125	SD125	TD125	PD125	QD125	HS125	HP125		HN125
230	○	○	○	○	○	○	○	○	○	○	○	○	○	○	○	○	○	○	○
221	○	○	○	○	○	○	○	○	○	○	○	○	○	○	○	○	○	○	○
205	○	○	○	○	○	○	○	○	○	○	○	○	○	○	○	○	○	○	○
200	○	○	○	○	○	○	○	○	○	○	○	○	○	○	○	○	○	○	○
187	○	○	○	○	○	○	○	○	○	○	○	○	○	○	○	○	○	○	○
160	○	○	○	○	○	○	○	○	○	○	○	○	○	○	○	○	○	○	○
150	○	○	○	○	○	○	S150	T150	○	○	GA150	SD150	TD150	PD150	QD150	HS150	HP150	HN150	
145	○	○	○	○	F6	X6	○	○	○	○	○	○	○	○	○	○	○	○	○
139	○	○	○	○	F13	○	○	○	○	○	○	○	○	○	○	○	○	○	○
136	○	○	○	○	○	X9	S136	T136	P136	Q136	GA136	SD136	TD136	PD136	QD136	HS136	HP136	HN136	
135	○	○	○	○	○	○	○	○	○	○	○	○	○	○	○	○	○	○	○
133	○	○	○	○	F8	○	○	○	○	○	○	○	○	○	○	○	○	○	○
130	○	○	○	○	F4	○	○	○	○	○	GA130	SD130	TD130	PD130	QD130	○	○	○	
125	KG3	XG3	K3	X3	○	○	S125	T125	P125	Q125	GA125	SD125	TD125	PD125	QD125	HS125	HP125	HN125	
123	○	○	○	○	○	○	○	○	○	○	○	○	○	○	○	○	○	○	○
120	○	○	○	○	○	○	○	○	○	○	○	○	○	○	○	○	○	○	○
115	KG2	XG2	K2	X2	F2	○	S115	T115	P115	Q115	GA115	SD115	TD115	PD115	QD115	○	○	○	
105	○	○	○	○	○	○	○	○	○	○	○	○	○	○	○	○	○	○	○
102	KG1	XG1	K1	X1	F1	○	S102	T102	P102	Q102	GA102	SD102	TD102	PD102	QD102	○	○	○	
97	○	○	○	○	○	○	○	○	○	○	○	○	○	○	○	○	○	○	○
95	○	○	○	○	○	○	○	○	○	○	○	○	○	○	○	○	○	○	○
86	KG18	XG18	K18	X18	F18	○	○	○	○	○	GA86	○	○	○	○	○	○	○	○
76	○	○	○	○	○	○	○	○	○	○	GA76	○	○	○	○	○	○	○	○
I_r (A) Rated Current	2	3	2	3	3	4	10	15 16	20	25	50	10	15 16	20	25	5	10	15	
U_r (VDC) Rated Voltage	60						100		120		125				200				
Product Structure	<p>Radial Shape (Screw Hole)</p>						<p>Radial Shape</p>				<p>Axial Shape (Flat Electrode)</p>								

Lead wire can be customized.